

L COMPACT STATIONARY CABINET



L COMPACT STATIONARY CABINET

The L Compact Stationary Cabinet has been developed to better meet our customers' needs in terms of dimensions offered, drawer configurations and accessories that fit in a compact cabinet.

The L Compact Stationary Cabinet is 18" wide and comes in two depths (21" and 27") and five heights (24", 28", 30", 34" and 40"). A 2" or 4" painted steel or stainless steel base can also be added to raise the cabinet height slightly or to create more space for feet. With the security system, you can lock all the drawers with a single action.

There are 6 different drawer heights available from 3" to 12", and the drawers can be accessorized with partitions, dividers and plastic bins for optimal organization of your parts. Each drawer has a 100lb. load capacity and an ergonomic, easy-grip handle.

The unique shape of the L drawer is a Rousseau Metal Inc. trademark.

The L Compact Stationary Cabinet is an excellent alternative to the R heavy-duty line. Learn more in the following pages.



L3ABD-2418L3C

L3ABD-3442L3C

THE ROUSSEAU DIFFERENCE



100lb. load capacity per drawer.

100% extension for both drawer depths.

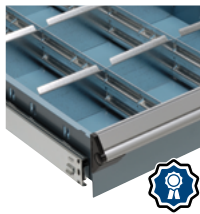

Partitions and dividers are clipped in.

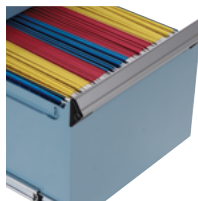

Wide variety of drawer accessories available: full-depth partitions, dividers, plastic bins, hanging file holders, protective foam, etc.



Central locking on the cabinet housing.

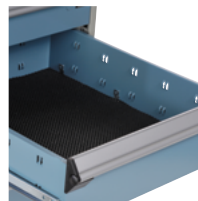

Six drawer heights available: 3", 4", 5", 6", 8" and 12".



LIFETIME WARRANTY

The Rousseau drawer rolling mechanism is covered by a lifetime warranty.

PRECONFIGURED MODELS – CABINETS

HERE ARE SOME OF OUR MOST POPULAR PRECONFIGURED MODELS OF THE L COMPACT STATIONARY CABINETS

- The doors are factory installed with hinges on the left. They can be installed on the right upon request
- To order a lock on the cabinet housing (for models with more than one drawer) or on the door, add **L3** to the end of the product number
- To add an L50 electronic lock to a door or to your L cabinet, see **page 31**
- To order a cabinet with a 4" base, add **C** to the end of the product number for a painted steel base or **D** for a stainless steel base, e.g., L3ABD-2401L3 C for an 18"W x 21"D x 24"H cabinet, with four drawers, a lock and a 4"H painted steel base



IMPORTANT

Drawer compartments are included in all models. See the table for the number of compartments.

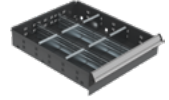

To order drawers without compartments, replace the last two digits of the model number with the next even number up.

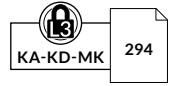

e.g., L3ABD-2401 with L3ABD-2402 without

NUMBER OF COMPARTMENTS (LAYOUT CODE)

DRAWER DIMENSIONS	18"W x 21"D	18"W x 27"D
3"H to 5"H	9 (0206)	9 (0206)
6"H and 8"H	6 (0104)	6 (0104)
12"H	4 (0102)	4 (0102)

24" HIGH (W x D x H)



4 DRAWERS
L3ABD-2401__ 18" x 21" x 24"
L3ABG-2401__ 18" x 27" x 24"



4 DRAWERS
L3ABD-2403__ 18" x 21" x 24"
L3ABG-2403__ 18" x 27" x 24"



4 DRAWERS
L3ABD-2405__ 18" x 21" x 24"
L3ABG-2405__ 18" x 27" x 24"



3 DRAWERS
L3ABD-2407__ 18" x 21" x 24"
L3ABG-2407__ 18" x 27" x 24"



4 DRAWERS
L3ABD-2409__ 18" x 21" x 24"
L3ABG-2409__ 18" x 27" x 24"

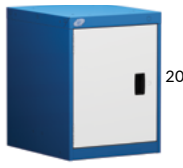

1 DOOR / 1 SHELF
L3ABD-2412__ 18" x 21" x 24"
L3ABG-2412__ 18" x 27" x 24"

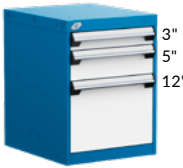

3 DRAWERS
L3ABD-2421__ 18" x 21" x 24"
L3ABG-2421__ 18" x 27" x 24"



3 DRAWERS
L3ABD-2415__ 18" x 21" x 24"
L3ABG-2415__ 18" x 27" x 24"



4 DRAWERS
L3ABD-2417__ 18" x 21" x 24"
L3ABG-2417__ 18" x 27" x 24"



5 DRAWERS
L3ABD-2419__ 18" x 21" x 24"
L3ABG-2419__ 18" x 27" x 24"

28" HIGH (W x D x H)



4 DRAWERS
L3ABD-2801__ 18" x 21" x 28"
L3ABG-2801__ 18" x 27" x 28"



4 DRAWERS
L3ABD-2807__ 18" x 21" x 28"
L3ABG-2807__ 18" x 27" x 28"



2 DRAWERS
L3ABD-2809__ 18" x 21" x 28"
L3ABG-2809__ 18" x 27" x 28"

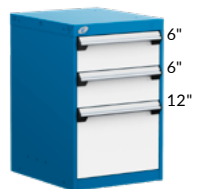

3 DRAWERS
L3ABD-2811__ 18" x 21" x 28"
L3ABG-2811__ 18" x 27" x 28"



4 DRAWERS
L3ABD-2819__ 18" x 21" x 28"
L3ABG-2819__ 18" x 27" x 28"



6 DRAWERS
L3ABD-2821__ 18" x 21" x 28"
L3ABG-2821__ 18" x 27" x 28"



3 DRAWERS
L3ABD-2803__ 18" x 21" x 28"
L3ABG-2803__ 18" x 27" x 28"



2 DOORS / 1 SHELF
L3ABD-2828__ 18" x 21" x 28"
L3ABG-2828__ 18" x 27" x 28"



1 DRAWER / 1 DOOR
L3ABD-2829__ 18" x 21" x 28"
L3ABG-2829__ 18" x 27" x 28"



4 DRAWERS
L3ABD-2835__ 18" x 21" x 28"
L3ABG-2835__ 18" x 27" x 28"

PRECONFIGURED MODELS – CABINETS

34" HIGH (W × D × H)



5 DRAWERS
L3ABD-3403__ 18" × 21" × 34"
L3ABG-3403__ 18" × 27" × 34"

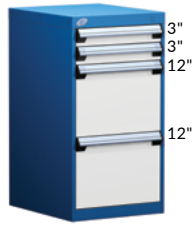

4 DRAWERS
L3ABD-3407__ 18" × 21" × 34"
L3ABG-3407__ 18" × 27" × 34"



1 DRAWER / 1 DOOR / 1 SHELF
L3ABD-3411__ 18" × 21" × 34"
L3ABG-3411__ 18" × 27" × 34"



5 DRAWERS
L3ABD-3415__ 18" × 21" × 34"
L3ABG-3415__ 18" × 27" × 34"



5 DRAWERS
L3ABD-3419__ 18" × 21" × 34"
L3ABG-3419__ 18" × 27" × 34"



4 DRAWERS
L3ABD-3421__ 18" × 21" × 34"
L3ABG-3421__ 18" × 27" × 34"

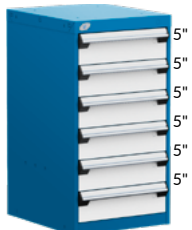

6 DRAWERS
L3ABD-3405__ 18" × 21" × 34"
L3ABG-3405__ 18" × 27" × 34"



1 DOOR / 1 SHELF
L3ABD-3436__ 18" × 21" × 34"
L3ABG-3436__ 18" × 27" × 34"



6 DRAWERS
L3ABD-3437__ 18" × 21" × 34"
L3ABG-3437__ 18" × 27" × 34"

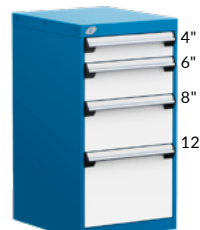

4 DRAWERS
L3ABD-3447__ 18" × 21" × 34"
L3ABG-3447__ 18" × 27" × 34"

40" HIGH (W × D × H)



6 DRAWERS
L3ABD-4005__ 18" × 21" × 40"
L3ABG-4005__ 18" × 27" × 40"

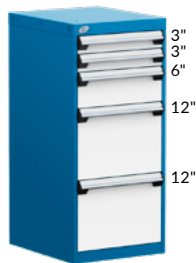

5 DRAWERS
L3ABD-4047__ 18" × 21" × 40"
L3ABG-4047__ 18" × 27" × 40"

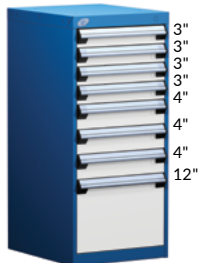

8 DRAWERS
L3ABD-4011__ 18" × 21" × 40"
L3ABG-4011__ 18" × 27" × 40"



4 DRAWERS / 1 DOOR / 1 SHELF
L3ABD-4015__ 18" × 21" × 40"
L3ABG-4015__ 18" × 27" × 40"

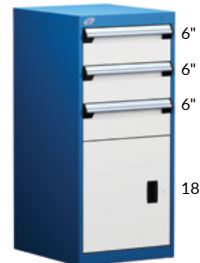

3 DRAWERS / 1 DOOR
L3ABD-4017__ 18" × 21" × 40"
L3ABG-4017__ 18" × 27" × 40"

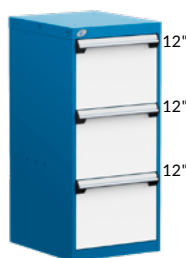

3 DRAWERS
L3ABD-4007__ 18" × 21" × 40"
L3ABG-4007__ 18" × 27" × 40"



6 DRAWERS
L3ABD-4025__ 18" × 21" × 40"
L3ABG-4025__ 18" × 27" × 40"

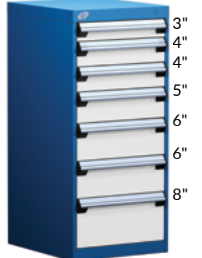

7 DRAWERS
L3ABD-4027__ 18" × 21" × 40"
L3ABG-4027__ 18" × 27" × 40"



6 DRAWERS
L3ABD-4029__ 18" × 21" × 40"
L3ABG-4029__ 18" × 27" × 40"

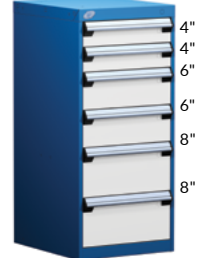

6 DRAWERS
L3ABD-4031__ 18" × 21" × 40"
L3ABG-4031__ 18" × 27" × 40"

PRECONFIGURED MODELS – DRAWER COMPARTMENTS

DRAWER DIMENSIONS

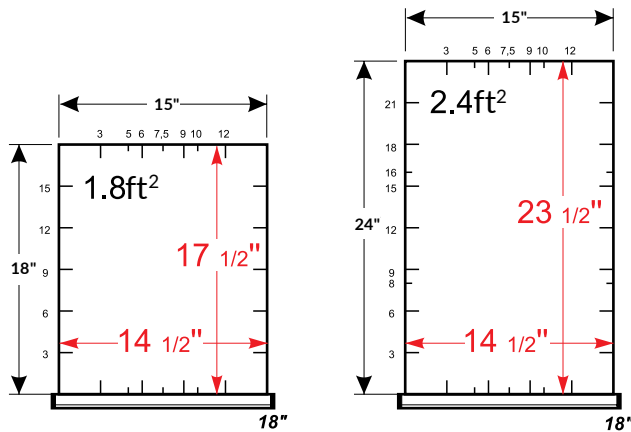

CHOOSE DRAWERS FROM OUR SELECTION OF PRECONFIGURED COMPARTMENT LAYOUTS

00 for subdividing kit only
51 for a drawer in a cabinet with compartments

L __ BD-A0200 __

Drawer height :
 3", 4", 5", 6", 8" and 12"

L3 Drawer lock
 B Lock-in mechanism

e.g., L51BD-A020008 L3 B

For an 18"W x 21"D drawer with compartments, 8" drawer height, an L3 lock and a lock-in mechanism on the drawer.

18" x 21" (W x D) DRAWERS

PARTITIONS AND DIVIDERS

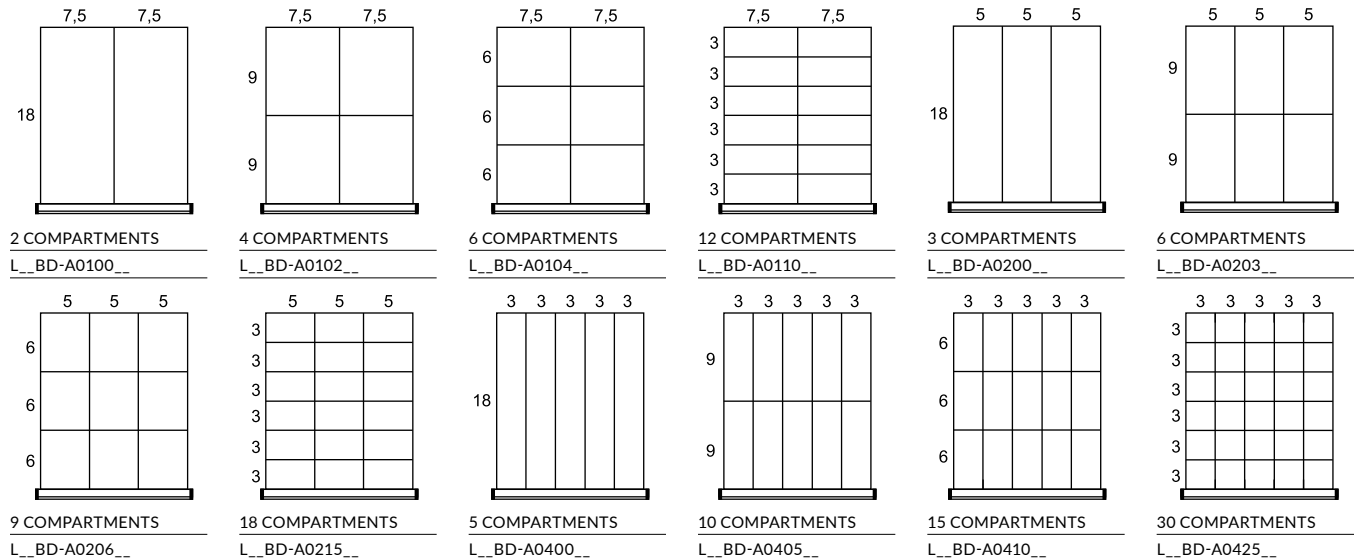

PLASTIC BINS

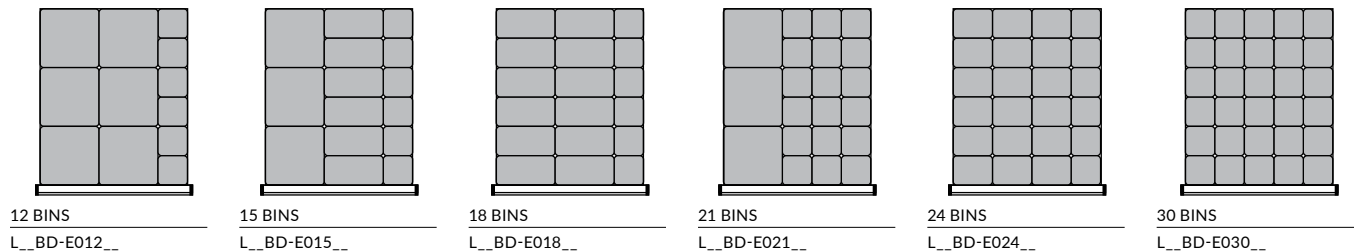

FOAM/LINERS

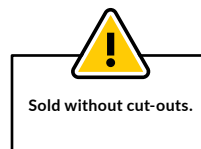
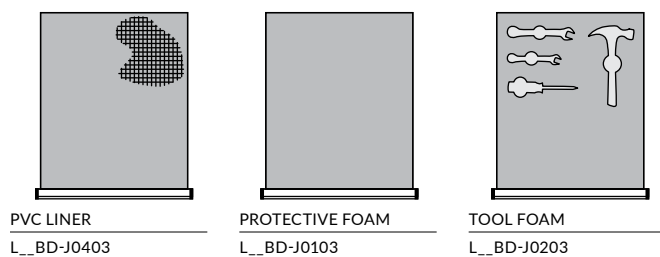

FILE HOLDERS

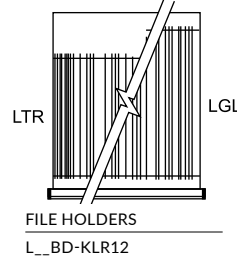

PRECONFIGURED MODELS – DRAWER COMPARTMENTS

18" x 27" (W x D) DRAWERS

PARTITIONS AND DIVIDERS

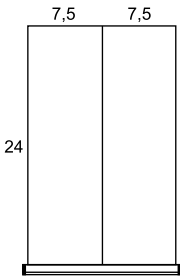

2 COMPARTMENTS
L__BG-A0100__

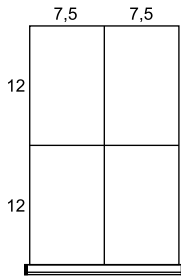

4 COMPARTMENTS
L__BG-A0102__

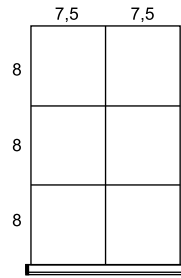

6 COMPARTMENTS
L__BG-A0104__

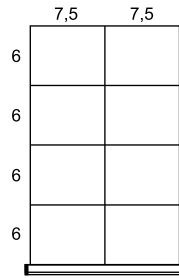

8 COMPARTMENTS
L__BG-A0106__

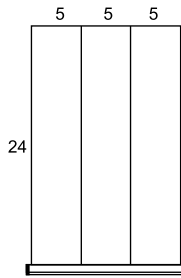

3 COMPARTMENTS
L__BG-A0200__

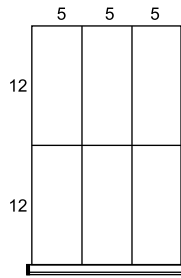

6 COMPARTMENTS
L__BG-A0203__

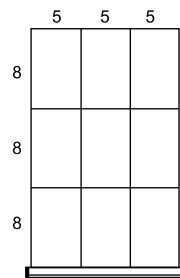

9 COMPARTMENTS
L__BG-A0206__

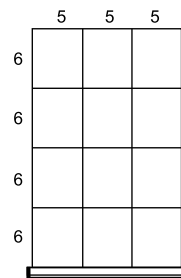

12 COMPARTMENTS
L__BG-A0209__

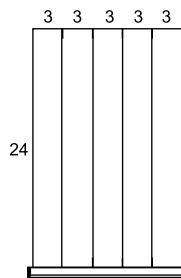

5 COMPARTMENTS
L__BG-A0400__

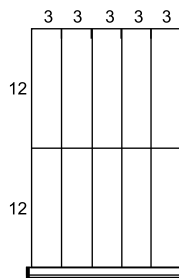

10 COMPARTMENTS
L__BG-A0405__

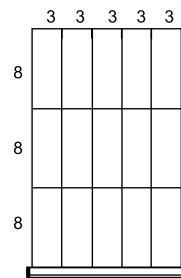

15 COMPARTMENTS
L__BG-A0410__

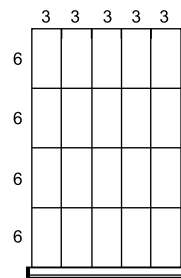

20 COMPARTMENTS
L__BG-A0415__

PLASTIC BINS

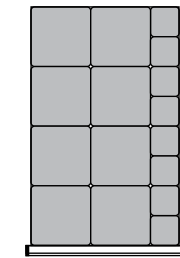

16 BINS
L__BG-E016__

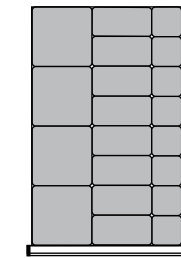

20 BINS
L__BG-E020__

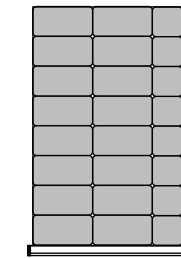

24 BINS
L__BG-E024__

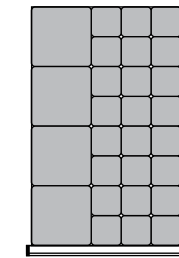

28 BINS
L__BG-E028__

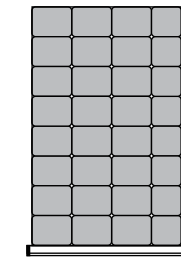

32 BINS
L__BG-E032__

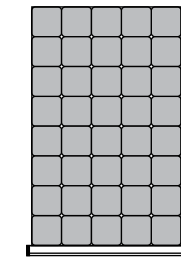

40 BINS
L__BG-E040__

FOAM/LINERS

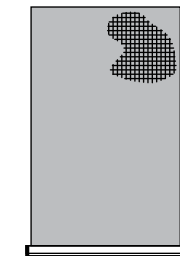

PVC LINER
L__BG-J0403

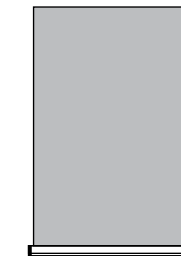

PROTECTIVE FOAM
L__BG-J0103

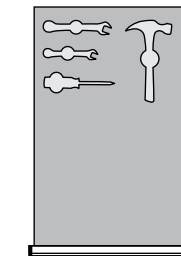

TOOL FOAM
L__BG-J0203



FILE HOLDERS

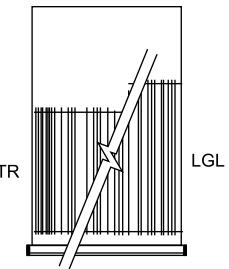

FILE HOLDERS
L__BG-KLR12

SECURITY MECHANISMS

ELECTRONIC LOCK SYSTEM FOR CABINET WITH DRAWERS

L50



- Electronically locks all drawers in the cabinet at the same time
- No key required
- Up to 20 different users can be programmed
- 4-8 digit access codes
- Simplifies access management to drawers
- To order the complete mechanism with a cabinet with drawers, order an LB00-DDHHL50
- To order as a replacement lock, order an HA60-L50

PRODUCT NO.

L50

ELECTRONIC LOCK FOR DOORS

L50



- Electronically locks a cabinet door
- No key required
- Up to 20 different users can be programmed
- 4-8 digit access codes
- Compatible with LB30 integrated doors
- To order: Add L50 to the door product code, e.g. LB30-1812L50

PRODUCT NO.

L50

NOTE: Cannot be retrofitted.

DRAWER LOCK

L3

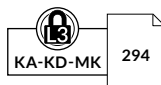

- Two keys provided with each lock
- Compatible with all drawer dimensions
- The mechanism (covered by a galvanized steel box) requires 3"W×1"D space inside the drawer
- To order: Add L3 to the product number for the drawer or preconfigured compartment layout e.g., LF31-182106L3
- For replacement parts or to retrofit this mechanism, order an HA51-L3

PRODUCT NO.

L3

NOTE: An LF91 security panel must be ordered to block access between two drawers and if two different user access rights are required.

CENTRAL LOCKING SYSTEM

L3 / LP

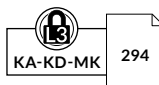

- Locks all drawers in the cabinet at the same time
- Easy to retrofit
- The drawer layout can be changed without touching the locking mechanism
- To order a lock, add L3 to the cabinet housing or preconfigured model number e.g., LA30-182134L3
- To order a safety hasp, add LP to the cabinet housing product number e.g., LA30-182134LP
- For replacement parts or to retrofit this mechanism, order an LB00-DDHH__ and specify the type of lock required

PRODUCT NO.

L3 Key lock

LP Safety hasp

DOOR LOCK

L3/LP



- Two keys provided with each lock
- To order a key lock, add L3 to the door product number e.g., LB30-1812L3
- To order a safety hasp, add LP to the door product number e.g., LB30-1812LP
- For replacement parts or to retrofit this mechanism, order an HA49-L3 or HA49-LP

PRODUCT NO.

L3 Key lock

LP Safety hasp

NOTE: An LF91 security panel must be ordered to block access between two doors and if two different user access rights are required.

LOCK-IN MECHANISM

B



- Activated with the right hand by sliding the mechanism with thumb
- The drawer closes without having to reactivate the sliding mechanism
- Stops drawers from opening on their own
- Easy to retrofit
- To order: Add B to the product number for the drawer or preconfigured compartment layout e.g., LF31-182106B
- For replacement parts or to retrofit this mechanism, order an LY01 and a LY02

PRODUCT NO.

B

ACCESSORIES

DRAWER AND HANDLE ACCESSORIES

HANDLE PROTECTOR

LF70



- Clips onto the drawer handle
- Made of transparent plastic
- Protects identification labels from dust, grease and dirt
- Easy to remove

PRODUCT NO.
LF70-18

HANDLE LABELS

LF71



- Labels to be attached to handles under the handle protector (LF70)
- 30 labels per page (10 pages)
- Print your own labels. A template is available on rousseau.com under Information Center > Document

PRODUCT NO.
LF71-425075

HANGING FILE BARS

LG31



- For storing hanging files
- Fits both letter and legal sizes
- For 12"H drawers

PRODUCT NO.
LG31-18

PVC DRAWER LINER

LG40



- Protects items stored in the drawer
- Non-slip material
- Can be installed under partitions and dividers
- Thickness: 3/32"

PRODUCT NO.	FOR DRAWER
LG40-1821-01	18"W x 21"D
LG40-1827-01	18"W x 27"D

PROTECTIVE FOAM

LG41

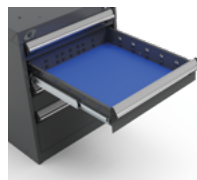

- Protects items stored in the drawer
- Includes one piece of 1/4"-thick blue foam

PRODUCT NO.	FOR DRAWER
LG41-1821-01	18"W x 21"D
LG41-1827-01	18"W x 27"D

NOTE: Partitions and dividers cannot be installed in the same drawer as this foam.

TOOL FOAM

LG42

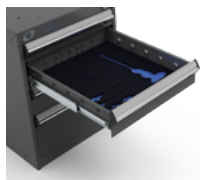

- Oil resistant and non-absorbent
- Includes one piece of 1/4"-thick blue foam
- Includes one piece of 1/2"-thick black foam
- Sold without cut-outs. Can be cut with a utility knife

PRODUCT NO.	FOR DRAWER
LG42-1821-01	18"W x 21"D
LG42-1827-01	18"W x 27"D

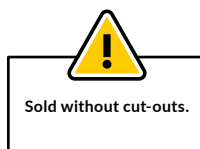

FRONT TO BACK PARTITION



LG02



- Divides the drawer along its depth
- Clip system locks dividers in place
- Galvanized steel
- Compatible with RG10 dividers, which can be used to make smaller compartments between each partition
- Compatible with plastic bins and PVC drawer liners

NOMINAL DRAWER HEIGHT (ACTUAL)	NOMINAL DRAWER DEPTH (ACTUAL)	
	21" (18")	27" (24")
3" (1½"H)	LG02-2103	LG02-2703
4" (2½"H)	LG02-2104	LG02-2704
5" (3½"H)	LG02-2105	LG02-2705
6" (4½"H)	LG02-2106	LG02-2706
8" (6½"H)	LG02-2108	LG02-2708
12" (8½"H)	LG02-2110	LG02-2710

PLASTIC BIN



RG20



- For easier storing, moving and managing of small parts
- Lightweight and durable
- For 3"H and 4"H drawers
- 45° angled rim for easy identification of bin contents and removal of bins
- Compatible with partitions and dividers
- 6" plastic bins can be subdivided

DIMENSIONS			PRODUCT NO.		
W	D	H	BIN	PARTITION	DIVIDER
3"	3"	2"	RG20-030302	-	-
4"	3"	2"	RG20-040302	-	-
6"	3"	2"	RG20-060302	RG22-0302	-
6"	6"	2"	RG20-060602	RG22-0602	RG24-0602
3"	3"	3"	RG20-030303	-	-
4"	3"	3"	RG20-040303	-	-
6"	3"	3"	RG20-060303	RG22-0303	-
6"	6"	3"	RG20-060603	RG22-0603	RG24-0603

NOTE: 2"H bins = 1½" actual height
3"H bins = 2½" actual height

DRAWER DIVIDER



RG10



- Dividers clip in place
- 45° angled edge for easy identification of compartment contents
- Adjustable in 3" increments (c/c)
- Galvanized steel

NOMINAL DIVIDER WIDTH	NOMINAL DRAWER HEIGHT (ACTUAL)					
	3" (1½"H)	4" (2¾"H)	5" (3¾"H)	6" (4½"H)	8" (6½"H)	12" (8½"H)
3"	RG10-03003	RG10-03004	RG10-03005	RG10-03006	RG10-03008	RG10-03010
5"	RG10-05003	RG10-05004	RG10-05005	RG10-05006	RG10-05008	RG10-05010
6"	RG10-06003	RG10-06004	RG10-06005	RG10-06006	RG10-06008	RG10-06010
7½"	RG10-07503	RG10-07504	RG10-07505	RG10-07506	RG10-07508	RG10-07510
9"	RG10-09003	RG10-09004	RG10-09005	RG10-09006	RG10-09008	RG10-09010
10"	RG10-10003	RG10-10004	RG10-10005	RG10-10006	RG10-10008	RG10-10010
12"	RG10-12003	RG10-12004	RG10-12005	RG10-12006	RG10-12008	RG10-12010
15"	RG10-15003	RG10-15004	RG10-15005	RG10-15006	RG10-15008	RG10-15010



CABINET TOPS

RESISTANT ACRYLIC/PVC PLASTIC LAMINATED TOP

WS08



- Ideal for assembly stations or for applications using solvents, oils or other chemical products
- Color: grey
- Premium-quality laminated top
- Excellent chemical resistance (can be in prolonged contact with a substance)
- Superior abrasion resistance compared with standard laminated tops
- Superior impact resistance compared with standard laminated tops
- Attractive appearance
- Thickness: 1½"

STEEL TOP WITH RUBBER MAT

RC32



- Non-slip rubber surface
- Includes edges on the sides and back
- Height: 1"

STAINLESS STEEL TOP

RC35



- Acts as a work surface and protects the cabinet from impacts
- Particle board top with stainless steel cover (#4 brushed finish)
- Excellent corrosion and chemical resistance
- Top complies with CARB regulations on formaldehyde emissions
- Includes welded corners for an attractive appearance
- Thickness: 1¾"

LAMINATED HARDWOOD TOP

WS14



- Top for general industrial applications
- Made from varnished hardwood slats
- Includes a 90° radius front edge for extra comfort
- High impact resistance
- Attractive appearance
- Thickness: 1¾"

PAINTED STEEL TOP

RC37



- Acts as a work surface and protects the cabinet from impacts
- Particle board top with painted steel cover
- Top complies with CARB regulations on formaldehyde emissions
- Includes welded corners for an attractive appearance
- Thickness: 1¾"

PLASTIC LAMINATED TOP

WS16



- Top for general use. Ideal for assembly stations, quality control and packaging
- Color: white
- Attractive appearance
- Easy to clean
- Includes a 90° radius front edge for extra comfort
- Thickness: 1½"

DISSIPATIVE TOP

WS17



- Top for electronics tasks. Ideal for electronics inspection or assembly stations
- Color: white
- Attractive appearance
- Easy to clean
- Includes a 90° radius front edge for extra comfort
- Dissipates electrical charges that can damage electronic components
- The resistance point to point and point to ground is between 10⁶ and 10⁹ Ω
- Thickness: 1½"

NOTE: Grounding accessories are sold separately, see page 171.

DIMENSIONS		CABINET TOPS						
W	D	ACRYLIC/PVC PLASTIC LAMINATED	LAMINATED HARDWOOD	PLASTIC LAMINATED	DISSIPATIVE	STEEL TOP WITH RUBBER MAT	STAINLESS STEEL	PAINTED STEEL
18"	21"		WS14-1821A*	WS16-1821A*		RC32-1821-01	RC35-1821	RC37-1821
	27"		WS14-1827A*	WS16-1827A*		RC32-1827-01	RC35-1827	RC37-1827
36"	21"	WS08-3621A*	WS14-3621A*	WS16-3621A*	WS17-3621A*	RC32-3621-01	RC35-3621	RC37-3621
	27"	WS08-3627A*	WS14-3627A*	WS16-3627A*	WS17-3627A*	RC32-3627-01	RC35-3627	RC37-3627
54"	21"	WS08-5421A*	WS14-5421A*	WS16-5421A*	WS17-5421A*	RC32-5421-01	RC35-5421	RC37-5421
	27"	WS08-5427A*	WS14-5427A*	WS16-5427A*	WS17-5427A*	RC32-5427-01	RC35-5427	RC37-5427

NOTE: * Please check with your Customer Service representative for lead times.

ESD PROTECTION

ESD CABINET

LC50



- Special paint dissipates electrical charges
- Includes a grounding cord and ground wrist strap socket. The cord resistance is 1MΩ
- To order a cabinet with ESD protection, please order an LC50-01 grounding kit and specify dissipative paint color Black 090

PRODUCT NO.
LC50-01

NOTE: Contact Customer Service for ESD paint prices.

GROUNDING WRIST STRAP



- Made of stretch fabric
- Includes a 6" cord with 1MΩ resistance
- Dissipates electric charges that can damage electronic components

PRODUCT NO.
70000320

CONDUCTIVE PLASTIC BINS



245

DISSIPATIVE TOP



144

BASES

LEVELING GLIDE KIT

LA74

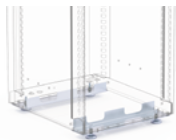

- Adjusts the height of cabinets 1½" to 2" on uneven floor surfaces
- Can be installed under cabinets with or without bases
- Includes two brackets and four leveling glides

PRODUCT NO. WIDTH
LA74-1801 18"

FLOOR ANCHORING KIT

LA76

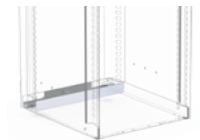

- For anchoring a cabinet (without base) to the floor
- Includes one bolt for concrete floors

PRODUCT NO. WIDTH
LA76-1801 18"

STACKING CABINETS

STACKING KIT

LA78

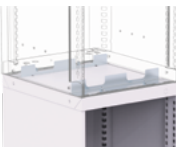

- For stacking an L compact cabinet on top of another
- Installs on the bottom of the top cabinet
- Includes two brackets and anchoring hardware

PRODUCT NO. WIDTH
LA78-1801 18"



L3XJD-2802L3

HOUSINGS

L COMPACT CABINET HOUSING

LA30

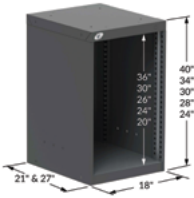

- Drawers, shelves and doors can be installed in the housing
- The housing units include knockouts:
 - On the top: for stacking an LD75 Housing for Drawer Unit or another LA30 L Compact Cabinet Housing. For the latter, order an LA78 Stacking Kit
 - On the sides and back: for assembling cabinets side to side and back to back, or for installing under a work surface. For the latter, order RA70 Cabinet Attachment Bars
- A 2" painted or stainless steel base can be added to make cabinet heights of 26", 30", 32", 36" and 42"
- A 4" painted or stainless steel base can be added to make cabinet heights of 28", 32", 34", 38" and 44"
- To order a lock on the housing that locks all drawers at the same time, add L3 to the product number, [see page 31](#)
- To order a safety hasp, add LP to the product number, [see page 31](#)
- For factory installation of an electronic lock, order an LB00-DDHHL50, [see page 31](#)



PRODUCT NO.	W x D x H
LA30-182124__	18" x 21" x 24"
LA30-182128__	18" x 21" x 28"
LA30-182130__	18" x 21" x 30"
LA30-182134__	18" x 21" x 34"
LA30-182140__	18" x 21" x 40"
LA30-182724__	18" x 27" x 24"
LA30-182728__	18" x 27" x 28"
LA30-182730__	18" x 27" x 30"
LA30-182734__	18" x 27" x 34"
LA30-182740__	18" x 27" x 40"

L COMPACT DRAWER

LF31



- 100lb. load capacity, 100% extension
- Vast choice of accessories available to customize the drawer to your storage needs
- Precision ball bearing drawer slides included
- Easy hook-on assembly
- For preconfigured drawer compartment layouts, [see pages 29-30](#)
- Drawer heights available: 3", 4", 5", 6", 8" and 12"
- To order: Add the drawer height required to the product number, e.g., LF31-182106
- To order a drawer lock, add L3 to the drawer product number, e.g., LF31-182704L3. The mechanism (covered by a galvanized steel box) requires 3"W x 1"D space inside the drawer
- To order a drawer lock-in mechanism, add "B" to the drawer product number, e.g., LF31-182103B



PRODUCT NO.	W x D	INSIDE DIM.
LF31-1821_____	18" x 21"	15" x 18"
LF31-1827_____	18" x 27"	15" x 24"

L 3-SIDES ACCESS ROLL-OUT SHELF

LF44

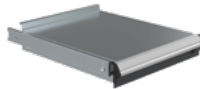

- 100lb. load capacity, 100% extension
- Precision ball bearing drawer slides included
- Easy hook-on assembly
- Galvanized steel top with 1 1/2" H back
- Total height: 4"

PRODUCT NO.	W x D	INSIDE DIM.
LF44-1821	18" x 21"	15" x 18"
LF44-1827	18" x 27"	15" x 24"

DRAWER AND ROLL-OUT SHELF DIMENSIONS

LA30

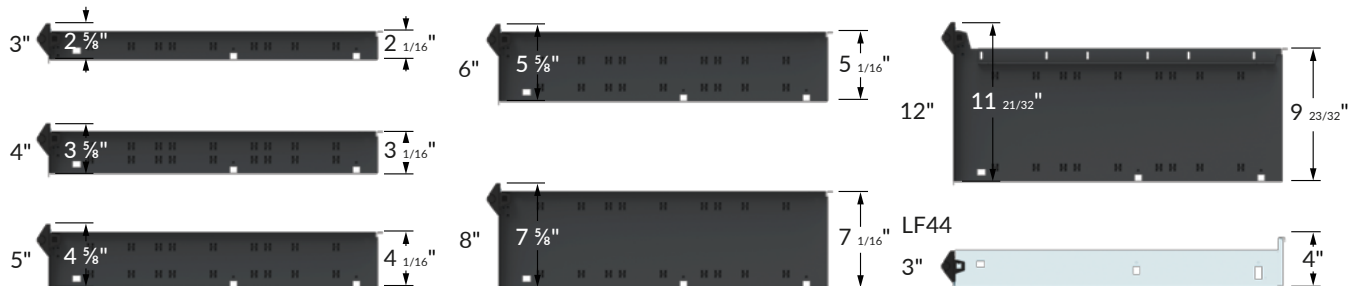

CABINET BASE

LA85 / LA86

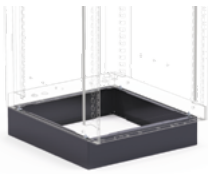

- Painted steel: LA85
- Stainless steel: LA86
- Heights available: 2" and 4"
- Recessed 2" from the front to create more space for feet
- Compatible with LA74 Leveling Glide Kit
- To order: Specify the type of steel required, e.g., LA86-182704 for an 18"W x 27"D x 4"H stainless steel base

PRODUCT NO.	W x D x H
LA__-182102	18" x 21" x 2"
LA__-182104	18" x 21" x 4"
LA__-182702	18" x 27" x 2"
LA__-182704	18" x 27" x 4"

NOTE: Not compatible with LA76 Floor Anchoring Kit, LA78 Stacking Kit and casters

INTEGRATED DOOR

LB30



- Seven standard heights available
- Black plastic recessed handle
- The doors are factory installed with hinges on the left. They can be installed on the right upon request
- An LB24 Adjustable Shelf must be ordered as a storage surface for doors installed above a drawer or another door
- To order a key lock, add L3 to the product number
- To order a safety hasp, add LP to the door product number
- To order an electronic lock for doors, add L50 to the product number

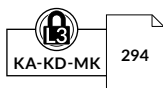

PRODUCT NO.	W x H
LB30-1812__	18" x 12"
LB30-1818__	18" x 18"
LB30-1820__	18" x 20"
LB30-1824__	18" x 24"
LB30-1826__	18" x 26"
LB30-1830__	18" x 30"
LB30-1836__	18" x 36"

SECURITY PANEL

LF91

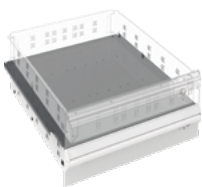

- Divides the cabinet up for use by more than one user
- Adjustable in 1" increments c/c
- Must be ordered to:
 - Block access between doors
 - Block access when a door with lock is installed under a drawer
 - Block the space left when a door is installed above a drawer
- Two security panel versions available for housings with or without a central locking mechanism
- Galvanized steel
- To order: Specify the housing depth, 21" or 27"

PRODUCT NO.	FOR LA30
LF91-18__01	With L3/LP on the housing
LF91-18__02	Without L3/LP on the housing

HOUSING FOR DRAWER UNIT

LD75

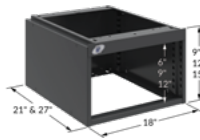

- Installs on a cabinet or under a work surface
- 100lb. load capacity for each drawer in the unit, max. 175lb. per unit
- Compatible with LF31 compact drawers (not included)
- To order: Specify the drawer unit housing depth required, 21" or 27"

PRODUCT NO.	INTERIOR DIM.
LD75-18__09	6"
LD75-18__12	9"
LD75-18__15	12"

DRAWER UNIT COVER

LD76

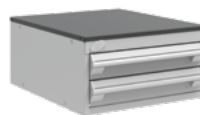

- Covers the top of an LD75 Housing for Drawer Unit when it is installed on a work surface

PRODUCT NO.	W x D
LD76-1821	18" x 21"
LD76-1827	18" x 27"

VERTICAL SECURITY BAR

LB10



- Locks all drawers in a cabinet with a key or padlock
- The key or safety hasp is located at the top of the bar to facilitate access
- Covers a bank of drawers from 20" to 36" high
- Easy to assemble
- Installs on the right-hand side
- To order: Specify the type of lock required, LP for a safety hasp or L3 for a standard key lock

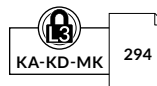

PRODUCT NO.	CABINET HEIGHT	VERTICAL SECURITY BAR HEIGHT
LB10-24__A	24"	20"
LB10-28__A	28"	24"
LB10-30__A	30"	26"
LB10-34__A	34"	30"
LB10-40__A	40"	36"

ADJUSTABLE SHELF

LB24



- For storage of bulky items
- Includes side and back edges
- Height can be adjusted in 1" increments c/c
- Up to 100lb. load capacity, evenly distributed
- Two adjustable shelf versions available for housings with or without a central locking mechanism
- Galvanized steel
- To order: Specify the housing depth, 21" or 27"

PRODUCT NO.	FOR LA30
LB24-18__01	With L3/LP/L50 on the housing
LB24-18__02	Without L3/LP/L50 on the housing